



aerospace
climate control
electromechanical
filtration
fluid & gas handling
hydraulics
pneumatics
process control
sealing & shielding



EHV Series Bladder Accumulators

High Pressure, 250 to 690 bar



ENGINEERING YOUR SUCCESS.

Description

Designed for high pressure hydraulic systems the EHV bladder accumulator is available in carbon & stainless steel, (70 to 690 bar, 0.2 to 57 Litres). Options with a flanged SAE fluid port and for high flow rates are also available.

The EHV bladder accumulator offers a reliable and efficient solution for storing energy under pressure. Utilizing comprehensive tools and resources including an applications database, CAD/CAM, finite element analysis, reliability studies and simulation we have optimized the design and performance of the accumulator. Parker Olaer bladder accumulators are suitable for use in more than 35 countries (all hydraulic accumulators for Europe are CE marked) and they can meet an extensive range of international and industry approvals.

The EHV Series bladder accumulator comes with an O-ring seal fluid port and 7/8" UNF gas connection as standard however other options are available.

Rigorous product testing and continuous product development help to ensure our hydraulic accumulators operate at optimum efficiency and can perform in the most demanding environments. Parker accumulator accessories such as Safety Blocks, Burst Discs and Permanent Charging Sets, can aid the safe installation and operation of the accumulators in any hydraulic system.

Parker Olaer have developed very sophisticated simulation software to optimize sizing recommendations for hydraulic accumulators. You can download the accumulator sizing software from www.Parker.com/acde.

Features/Benefits

- **Extensive range of international and industry approvals (PED 2014/68/EU, EN 14359, ATEX, ASME VIII div 1, SELO, CRN, AS1210, NR13, CUTR, DNV, BV Marine, ABS and GL)**
- **Rigorous product testing and continuous product development**
- **Large selection of materials and fittings to suit every hydraulic system.**
- **Parker Olaer offers a wealth of product knowledge and experience thus enabling us to provide first class technical support and customer service.**

Markets

- **Industrial**
- **Defense**
- **Renewable Energy**
- **Marine**
- **Mining**
- **Mobile**
- **Oil and Gas**
- **Processing**
- **Rail**

Applications

- **Hydraulic Power Units**
- **Ship Cranes**
- **Wind Turbines**
- **Plastic Presses**
- **Tooling Machines**
- **Construction/Mobile Vehicles**
- **Machine Tools**

Technical Specifications

The accumulator comprises a forged or welded steel shell, a rubber bladder and anti-extrusion system.

Volume: 0.2 to 200 Litres

Pressure: 70 to 690 bar

Shell Material: Options include; alloyed steel, stainless steel, aluminium, titanium and composites.

Bladder Materials: Various bladder materials available which are compatible with a wide range of fluids and temperatures.

Anti-extrusion System: Fluid port

Approvals: PED 2014/68/EU, ATEX, ASME VIII div 1, SELO, CUTR, DNV, BUREAU VERITAS MARINE, ABS, Germanischer Lloyd's.

Specials: - For special constructions please consult Parker.

Maximum pressure differential (P2/P0): 4:1

Nitrogen gas pressure : The maximum pressure (PS) with nitrogen purity > 99.8% N2 class 2.8, is indicated on the accumulator.

Check that the maximum allowable pressure is greater than that of the hydraulic

Accumulator working temperature determination example :

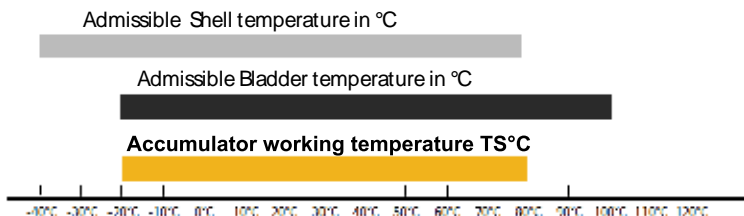

Spare Parts

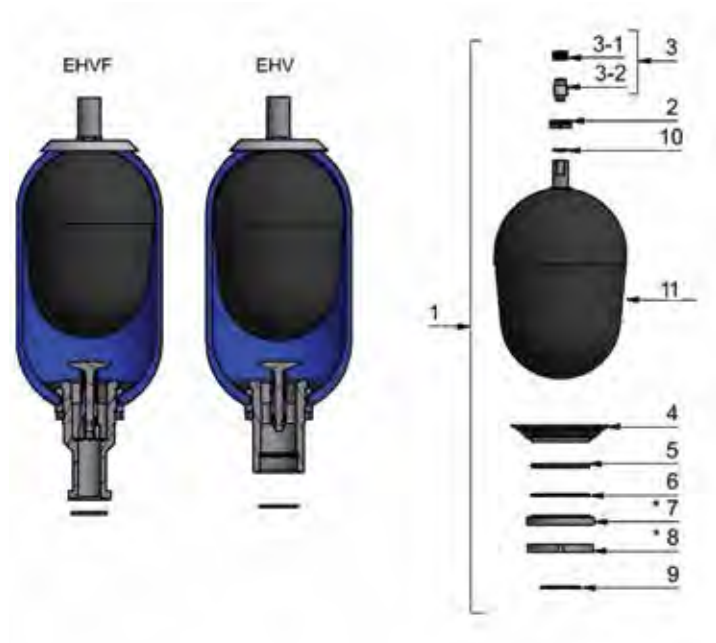

Item	Spare parts
1	Spare Parts Kit
2	Valve nut
3	Gas valve Assembly
3.1	Gas valve
3.2	Gas valve plug
4	Anti-extrusion ring
5	Fluid port seal
6	Back up seal ring
7*	Spacer
8*	Locking nut
9	O-ring fluid port
10	Back up ring (depending on the model)
11	Bladder

* These parts are not delivered in the spare parts kit
 (complete repair kit)

EHV Series: How to order a high pressure accumulator

EHV 24,5- 330 /90-A25GA-200/100

Product Type

EHV High pressure bladder
 ETHV High pressure transfer bladder
 EHVf High pressure bladder flange

Volume in L (up to 4 Characters)

0,2 for 0,2 Liter
 20 for 20 Liters
 24,5 for 24,5 Liters

Maximum Working Pressure

120 for 120 bar max working pressure (stainless steel range)
 330 for 330 bar max working pressure
 350 for 350 bar max working pressure
 690 for 690 bar max working pressure

*If the product is not CE, use highest MWP according to regulation relevant to the product (see Approvals PAGES 84&85)

Approvals* According to:-

00 PED2014/68/EU, article 4.3	86 PED2014/68/EU + ASME VIII div 1 app 22 + SELO
11 PED2014/68/EU + BV Marine	88 PED2014/68/EU + SELO
13 PED2014/68/EU, article 4.3 + BV Marine	90 PED2014/68/EU
23 PED2014/68/EU, article 4.3 + ABS	91 ASME VIII div 1 app 22 + AS1210
24 PED2014/68/EU + DNVGL	92 ASME VIII div 1 app 22 + CRN
41 PED2014/68/EU + ABS	94 PED2014/68/EU + ASME VIII div 1 app 22
43 PED2014/68/EU, article 4.3 + ABS	AA PED2014/68/EU + NR13
48 ASME VIII div 1 app 22	AE ASME VIII div 1 + NR13
71 CUTR 032/2013	AU ASME VIII div 1 + CUTR 032/2013
83 PED2014/68/EU + AS1210	
85 PED2014/68/EU, article 4.3 + SELO	

Material (Shell and Fluid Port)

A All parts in carbon steel with Epoxy paint for shell only [-40°C;+80°C]
 B Carbon Steel shell + Internal Protection Epoxy 80 µm + stainless steel fluid port and valve
 C Carbon Steel shell + Int- Ext Protection Kanigen 50 µm + stainless steel fluid port and valve
 D Carbon Steel shell + Int- Ext Protection Blue Rilsan 200-300 µm + carbon steel fluid port and valve
 E Carbon Steel shell + stainless steel fluid port and valve
 F Carbon steel shell + Internal Protection Teflon 40-50 µm
 I All parts in stainless steel [-40°C;+80°C]
 R Carbon Steel shell + Int- Ext Protection Blue Rilsan 200-300 µ + stainless steel fluid port and valve
 Z Special

Bladder Mix

02 Mix 02 [-32°C;+115°C] Hydrin C	37 For Mix 37 [-59°C;+110°C] Nitrile Extreme Low Temp
10 Mix 10 [-30°C;+80°C] Nitrile Low Temperature	40 For Mix 40 [-15°C;+120°C] Butyl
20 Mix 20 [-6°C;+100°C] Nitrile Heavy Duty	47 For Mix 47 [-40°C;+120°C] EPDM
25 Mix 25 [-20°C;+100°C] Nitrile standard	80 For Mix 80 [-20°C;+140°C] Viton
30 Mix 30 [-5°C;+115°C] Nitrile Low Permeability	E2 For Mix E2 [-15°C;+100°C] Nitrile
35 Mix 35 [0°C;+130°C] Nitrile high temperature	XL For Mix XL [-10°C;+100°C] Nitrile very low permeation

Fluid Port Configuration

A Gas cyl. 1/2" (max flow rate: 120L/min)	G Gas cyl. 2" (max flow rate: 900L/min)	R Flange BR 400-38 (max flow rate: 900L/min, EHV 10L to 57L)
B Gas cyl. 3/4" (max flow rate: 240L/min)	H Gas cyl.2" DA (max flow rate: 1200L/min)	S Flange BR 400-25 (max flow rate: 450L/min, EHV 2,5L to 10L)
C Gas cyl. 1" (max flow rate: 360L/min)	J Gas cyl.2"1/2 GD (max flow rate 1800 L/min)	Z Special
D Gas cyl. 1"1/4" (max flow rate: 450L/min)	M Metric M40 x1.5	
E Gas cyl. 1"1/4" DA (max flow rate: 570L/min)	N Metric M50 x1.5	

Gas Valve Configuration

0 No gas valve	F Gas Valve Type - 5/8"- 18 UNF + Burst disc
A Gas Valve Type - 5/8"- 18 UNF	G Gas Valve Type - 7/8"- 14 UNF + Burst disc
B Gas Valve Type - 7/8"- 14 UNF	H Gas Valve Type- 7/8" -14 UNF integrated + Burst disc
C Gas Valve Type- 7/8" -14 UNF integrated	I Gas Valve Type - 5/8"- 18 UNF integrated + Burst disc
D Gas Valve Type - 5/8"- 18 UNF integrated	J Gas Valve Type- 7/8" -14 UNF high pressure + Burst disc
E Gas Valve Type- 7/8" -14 UNF high pressure	Z Special

Fluid Type

0 Not applicable
 1 Fluid Type 1 CE Fluid Group 1
 2 Fluid Type 2 - CE Fluid Group 2

Special

00 No Special features or configuration	D1 Standard documentation + Leak test report	ASME certified accumulator according to ASME VIII Div.1 :
EX ATEX	D2 Standard documentation + Descriptive statement + Design calculation note	30 MWP = 3000 psi (207 bar)
EZ ATEX with other special configuration	ZZ Special configuration or several options	36 MWP = 3600 psi (248 bar)
EU All components sourced in EU		40 MWP = 4000 psi (276 bar)
SP Special painting		50 MWP = 5000 psi (345 bar)

Precharge @ 20°C in Bar

When at storage pressure (Keep empty)*

*Parker precharge accumulator with 2 Bar for storage

100 When at storage (keep empty) example for 100 Bar precharge

EHV Series 330 bar, 10 to 57 Litres

Standard version (Carbon Steel shell/NBR mix) compatible with mineral oils (2).
 According to PED 2014/68/EU, EN 14359, Fluid Group 2 (3).

Product Prices, Part numbers, Accessories

Type Part number	Valve	Adaptor*	Clamps	Support Bracket	Mounting Frame	Lifting Eye on gas side	Complete Repair Kit
	see drawing	Threaded Part number	Model (quantity) Part number	Model Part number	Model Part number	Model Part number	Model Part number
EHV 10-330/90-A25GA-200 10837001125	A	G 1" cyl	D226 (2)	CE159A	EF2		KIT EHV 10-330/90-A25GA 19028900225
EHV 10-330/90-A25GB-200 10865401125	B	04557000223	20251503648	20109003620	20217600125	10912700200	KIT EHV 10-330/90-A25GB 19035800225
EHV 12-330/90-A25GA-200 10867101125	A	G 1" cyl	D226 (2)	CE159A	EF2		KIT EHV 12-330/90-A25GA 19032100225
EHV 12-330/90-A25GB-200 10867401125	B	04557000223	20251503648	20109003620	20217600125	10912700200	KIT EHV 12-330/90-A25GB 19035900225
EHV 20-330/90-A25GA-200 10837101125	A	G 1" cyl	D226 (2)	CE159A	EF2		KIT EHV 20-330/90-A25GA 19029000225
EHV 20-330/90-A25GB-200 10865501125	B	04557000223	20251503648	20109003620	20217600125	10912700200	KIT EHV 20-330/90-A25GB 19036000225
EHV 24.5-330/90-A25GA-200 10837201125	A	G 1" cyl	D226 (2)	CE159A	EF2		KIT EHV 24.5-330/90-A25GA 19029400225
EHV 24.5-330/90-A25GB-200 10865601125	B	04557000223	20251503648	20109003620	20217600125	10912700200	KIT EHV 24.5-330/90-A25GB 19036300225
EHV 32-330/90-A25GA-200 10837301125	A	G 1" cyl	D226 (2)	CE159A	EF3		KIT EHV 32-330/90-A25GA 19029100225
EHV 32-330/90-A25GB-200 10865701125	B	04557000223	20251503648	20109003620	20217700125	10912700200	KIT EHV 32-330/90-A25GB 19036100225
EHV 42-330/90-A25GA-200 11112301125	A	G 1" cyl	D226 (2)	CE159A	EF3		KIT EHV 42-330/90-A25GA 19060800225
EHV 42-330/90-A25GB-200 11123601125	B	04557000223	20251503648	20109003620	20217700125	10912700200	KIT EHV 42-330/90-A25GB 19061100225
EHV 50-330/90-A25GA-200 11076701125	A	G 1" cyl	D226 (2)	CE159A	EF3		KIT EHV 50-330/90-A25GA 19054100225
EHV 50-330/90-A25GB-200 11076801125	B	04557000223	20251503648	20109003620	20217700125	10912700200	KIT EHV 50-330/90-A25GB 19054200225
EHV 57-330/90-A25GA-200 11112401125	A	G 1" cyl	D226 (2)	CE159A	EF3		KIT EHV 57-330/90-A25GA 19060900225
EHV 57-330/90-A25GB-200 11123801125	B	04557000223	20251503648	20109003620	20217700125	10912700200	KIT EHV 57-330/90-A25GB 19061200225

(2) For other fluids consult Parker

(3) For Fluid group 1 consideration : consult Parker

*For more adaptor options see pages 74 & 75

Model of valve stem
 5/8" 18 UNF
 (A)



Model of valve stem
 7/8" 14 UNF
 (B)

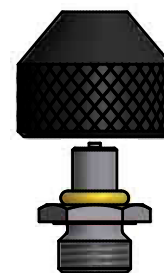

Type	Effective Gas vol. Litres	Max. Working pressure (PS) bar	Max Flow Rate l/min	Admissible Accumulator Temperature min/max (°C) (1)	Weight kg	Gas connection	Dimensions in mm							
							A max Height	B	C	øD	ød	øE	F on flats	G connection
EHV 10-330/90-A25GA	9.2	330	900	-20/+80	31	5/8" 18 UNF	587	103	66	226	22.5	101	70	G2"
EHV 10-330/90-A25GB						7/8" 14 UNF								
EHV 12-330/90-A25GA	11	330	900	-20/+80	36	5/8" 18 UNF	687	103	66	226	22.5	101	70	G2"
EHV 12-330/90-A25GB						7/8" 14 UNF								
EHV 20-330/90-A25GA	17.8	330	900	-20/+80	49	5/8" 18 UNF	897	103	66	226	22.5	101	70	G2"
EHV 20-330/90-A25GB						7/8" 14 UNF								
EHV 24.5-330/90-A25GA	22.5	330	900	-20/+80	56	5/8" 18 UNF	1032	103	66	226	22.5	101	70	G2"
EHV 24.5-330/90-A25GB						7/8" 14 UNF								
EHV 32-330/90-A25GA	32	330	900	-20/+80	81	5/8" 18 UNF	1420	103	66	226	22.5	101	70	G2"
EHV 32-330/90-A25GB						7/8" 14 UNF								
EHV 42-330/90-A25GA	42	330	900	-20/+80	87	5/8" 18 UNF	1562	103	66	226	22.5	101	70	G2"
EHV 42-330/90-A25GB						7/8" 14 UNF								
EHV 50-330/90-A25GA	48.5	330	900	-20/+80	110	5/8" 18 UNF	1936	103	66	226	22.5	101	70	G2"
EHV 50-330/90-A25GB						7/8" 14 UNF								
EHV 57-330/90-A25GA	51	330	900	-20/+80	116	5/8" 18 UNF	2032	103	66	226	22.5	101	70	G2"
EHV 57-330/90-A25GB						7/8" 14 UNF								

(1)Temperature range can change depending on shell and elastomer material. Please see bladder materials and Type (page 87)

Above dimensions are in mm and are subject to manufacturing tolerances.

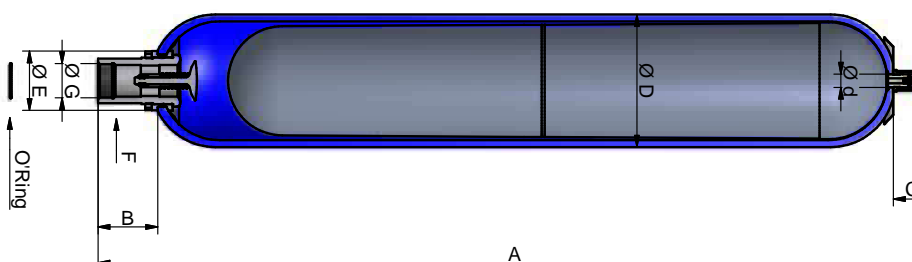

EHV Series 330 bar, 10 to 50 Litres, Marine

Standard version (Carbon Steel shell/NBR mix) compatible with mineral oils (2).
 According to PED 2014/68/EU, EN 14359, Fluid Group 2 (3).

Product, Part numbers, Accessories

/43 /24	/13 /11	/23 /41		Adaptor*	Clamps	Support Bracket	Mounting Frame	Lifting Eye on gas side	Complete Repair Kit
/24 : PED & DNV GL	/11 : PED & BV MARINE	/41 : PED & ABS	Valve model see drawing	Threaded	Model (quantity)	Model	Model	Model	Model
				Part number	Part number	Part number	Part number	Part number	Part number
EHV 10-330/24-A25GB-200 11168801125	EHV 10-330/11-A25GB-200 10999501125	EHV 10-330/41-A25GB-200 11165501125	B	G 1" cyl 04557000223	D226 (2) 20251503648	CE159A 20109003620	EF2 20217600125	10912700200	KIT EHV 10-330/XX-A25GB 19035800225
EHV 12-330/24-A25GB-200 11168901125	EHV 12-330/11-A25GB-200 10999601125	EHV 12-330/41-A25GB-200 11166501125	B	G 1" cyl 04557000223	D226 (2) 20251503648	CE159A 20109003620	EF2 20217600125	10912700200	KIT EHV 12-330/XX-A25GB 19035900225
EHV 20-330/24-A25GB-200 11169001125	EHV 20-330/11-A25GB-200 10999701125	EHV 20-330/41-A25GB-200 11166601125	B	G 1" cyl 04557000223	D226 (2) 20251503648	CE159A 20109003620	EF2 20217600125	10912700200	KIT EHV 20-330/XX-A25GB 19036000225
EHV 24.5-330/24-A25GB-200 11169101125	EHV 24.5-330/11-A25GB-200 10999801125	EHV 24.5-330/41-A25GB-200 11166701125	B	G 1" cyl 04557000223	D226 (2) 20251503648	CE159A 20109003620	EF2 20217600125	10912700200	KIT EHV 24.5-330/XX-A25GB 19036300225
EHV 32-330/24-A25GB-200 11169201125	EHV 32-330/11-A25GB-200 10999901125	EHV 32-330/41-A25GB-200 11166801125	B	G 1" cyl 04557000223	D226 (2) 20251503648	CE159A 20109003620	EF3 20217700125	10912700200	KIT EHV 32-330/XX-A25GB 19036100225
EHV 50-330/24-A25GB-200 11169401125	EHV 50-330/11-A25GB-200 11127901125	EHV 50-330/41-A25GB-200 11167001125	B	G 1" cyl 04557000223	D226 (2) 20251503648	CE159A 20109003620	EF3 20217700125	10912700200	KIT EHV 50-330/XX-A25GB 19054200225

(2) For other fluids consult Parker

(3) For Fluid group 1 consideration : consult Parker

*For more adaptor options see pages 74&75

Model of valve stem
 7/8" 14 UNF
 (B)



Volume in Litres	Max. Working Pressure (bar)	Effective Gas vol. Litres	Max. Working pressure (PS) bar	Max Flow Rate l/min	Admissible Accumulator Temperature min/max (°C) (1)	Weight kg	Gas connection	Dimensions in mm							
								A max Height	B	C	øD	ød	øE	F on flats	G connection
EHV 10L	330	9.2	330	900	-20/+80	31	7/8" 14 UNF	587	103	66	226	23	101	70	G2"
EHV 12L	330	11.0	330	900	-20/+80	36	7/8" 14 UNF	687	103	66	226	23	101	70	G2"
EHV 20L	330	17.8	330	900	-20/+80	49	7/8" 14 UNF	897	103	66	226	23	101	70	G2"
EHV 24.5L	330	22.5	330	900	-20/+80	56	7/8" 14 UNF	1032	103	66	226	23	101	70	G2"
EHV 32L	330	32	330	900	-20/+80	81	7/8" 14 UNF	1420	103	66	226	22.5	101	70	G2"
EHV 50L	330	49	330	900	-20/+80	110	7/8" 14 UNF	1936	103	66	226	22.5	101	70	G2"

(1)Temperature range can change depending on shell and elastomer material. Please see bladder materials and Type (page 87)

Above dimensions are in mm and are subject to manufacturing tolerances.

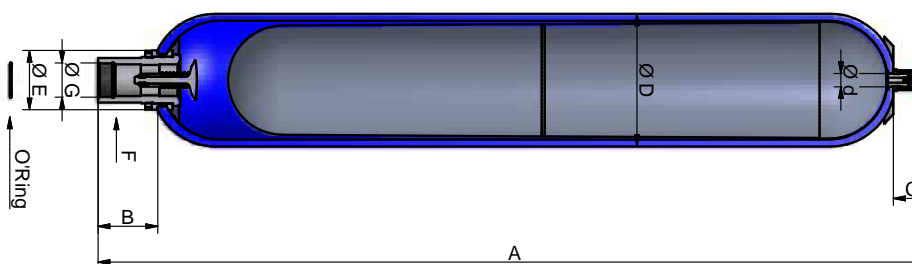

EHV Series 480 bar, 10 to 50 Litres, Marine

Standard version (Carbon Steel shell/NBR mix) compatible with mineral oils (2).
 According to PED 2014/68/EU, EN 14359, Fluid Group 2 (3).

Product, Part numbers, Accessories

/24		Adaptor*	Clamps	Support Bracket	Mounting Frame	Complete Repair Kit
/24 : PED&DNV GL	Valve model see drawing	Threaded Part number	Model (quantity) Part number	Model Part number	Model Part number	Model Part number
EHV 10-480/24-A25GE-200 11175801125	E	G 1" cyl 04557000223	D226 (2) 20251503648	CE159A 20109003620	EF2 20217600125	KIT EHV 10-480/XX-A25GE 19055702525
EHV 12-480/24-A25GE-200 11266801125	E	G 1" cyl 04557000223	D226 (2) 20251503648	CE159A 20109003620	EF2 20217600125	KIT EHV 12-480/BE-A25GE 19063002525
EHV 20-480/24-A25GE-200 11266901125	E	G 1" cyl 04557000223	D226 (2) 20251503648	CE159A 20109003620	EF2 20217600125	KIT EHV 20-480/XX-A25GE 19050002525
EHV 32-480/24-A25GE-200 11209601125	E	G 1" cyl 04557000223	D226 (2) 20251503648	CE159A 20109003620	EF3 20217700125	KIT EHV 32-480/XX-A25GE 19051302525
EHV 50-480/24-A25GE-200 11267001125	E	G 1" cyl 04557000223	D226 (2) 20251503648	CE159A 20109003620	EF3 20217700125	KIT EHV 50-480/XX-A25GE 19050302525

(2) For other fluids consult Parker

(3) For Fluid group 1 consideration : consult Parker

*For more adaptor options see pages 74&75

Model of valve stem
 7/8" 14 UNF
 (E)

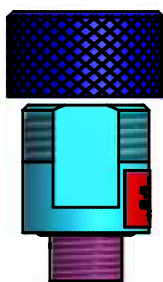

Volume in Litres	Max. Working Pressure (bar)	Effective Gas vol. Litres	Max. Working pressure (PS) bar	Max Flow Rate l/min	Admissible Accumulator Temperature min/max (°C) (1)	Weight kg	Gas connection	Dimensions in mm							
								A max Height	B	C	øD	ød	øE	F on flats	G connection
EHV 10L	480	9	480	900	- 20/+80	33	7/8" 14 UNF	593	103	74	228	22.5	101	70	G 2"
EHV12L	480	11	480	900	- 20/+80	43	7/8" 14 UNF	693	103	74	228	22.5	101	70	G 2"
EHV 20L	480	18	480	900	- 20/+80	63	7/8" 14 UNF	903	103	74	228	22.5	101	70	G 2"
EHV 32L	480	32.0	480	900	- 20/+80	97	7/8" 14 UNF	1428	103	74	228	23	101	70	G 2"
EHV 50L	480	48.5	480	900	- 20/+80	132	7/8" 14 UNF	1968	103	99	228	23	101	70	G 2"

(1)Temperature range can change depending on shell and elastomer material. Please see bladder materials and Type (page 87)

Above dimensions are in mm and are subject to manufacturing tolerances.

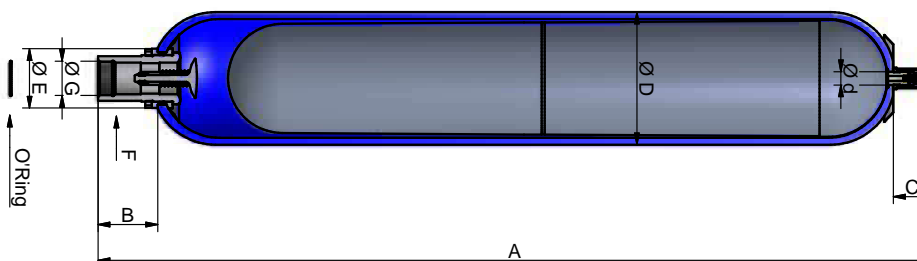

EHV Series 350 bar, 0.2 to 10 Litres

Standard version (Carbon Steel shell/NBR mix) compatible with mineral oils (2).
 According to PED 2014/68/EU, EN 14359, Fluid Group 2 (3).

Product, Part numbers, Accessories

Type Part number	Valve see drawing	Adaptor**	Clamps	Support Bracket	Mounting Frame	Lifting Eye on gas side	Complete Repair Kit
		Threaded Part number	Model (quantity) Part number	Model Part number	Model Part number	Model Part number	Model Part number
EHV 0.2-350/00-A20AD-200* 10876301120	D	G 1/4" cyl 4556500223	A56 (1) 20149203625				KIT EHV 0.2-350/00-A20AD 19001000220
EHV 0.5-350/00-A25BD-200* 10876401125	D	G 3/8" cyl 4556400223	E95 (1) 20250803648				KIT EHV 0.5-350/00-A25BD 19001100225
EHV 1-350/00-A25BC-200* 10845601125	C	G 3/8" cyl	E114 (1)	CE 89			KIT EHV 1-350/00-A25BC 19029700225
EHV 1-350/00-A25BB-200* 10866901125	B	04556400223	20251003648	20151903620			KIT EHV 1-350/00-A25BB 19036400225
EHV 1.6-350/90-A25BC-200 10998301125	C	G 3/8" cyl	E114 (1)	CE 89			KIT EHV 1.6-350/90-A25BC 19060700225
EHV 1.6-350/90-A25BB-200 11123501125	B	04556400223	20251003648	20151903620			KIT EHV 1.6-350/90-A25BB 19061000225
EHV 2.5-350/90-A25DC-200 10854701125	C	G 3/4" cyl	E114 (2)	CE 89			KIT EHV 2.5-350/90-A25DC 19029800225
EHV 2.5-350/90-A25DB-200 10866601125	B	04555200223	20251003648	20151903620		10912700200	KIT EHV 2.5-350/90-A25DB 19036500225
EHV 4-350/90-A25DC-200 10845401125	C	G 3/4" cyl	E168 (1)	CE108	EF1		KIT EHV 4-350/90-A25DC 19029900225
EHV 4-350/90-A25DB-200 10866101125	B	04555200223	20251303648	20118703620	20217500125	10912700200	KIT EHV 4-350/90-A25DB 19036600225
EHV 5-350/90-A25DC-200 10861201125	C	G 3/4" cyl	E114 (2)	CE 89			KIT EHV 5-350/90-A25DC 19030000225
EHV 5-350/90-A25DB-200 10866701125	B	04555200223	20251003648	20151903620		10912700200	KIT EHV 5-350/90-A25DB 19036700225
EHV 6-350/90-A25DC-200 10857401125	C	G 3/4" cyl	E168 (2)	CE108	EF1		KIT EHV 6-350/90-A25DC 19030100225
EHV 6-350/90-A25DB-200 10866201125	B	04555200223	20251303648	20118703620	20217500125	10912700200	KIT EHV 6-350/90-A25DB 19036800225
EHV 10-350/90-A25DC-200 10859701125	C	G 3/4" cyl	E168 (2)	CE108	EF1		KIT EHV 10-350/90-A25DC 19030200225
EHV 10-350/90-A25DB-200 10866301125	B	04555200223	20251303648	20118703620	20217500125	10912700200	KIT EHV 10-350/90-A25DB 19036900225

(2) For other fluids consult Parker

(3) For Fluid group 1 consideration : consult Parker

* According to Article 4.3 PED 2014/68/EU

** For more adaptor options see pages 74/75.

Model of valve stem
7/8" 14 UNF
(B)



Model of valve stem
integrated
7/8" 14 UNF
(C)



Model of valve stem
integrated
5/8" 18 UNF
(D)



Type Part number	Effective Gas vol. Litres	Max. Working pressure (PS) bar	Max Flow Rate l/min	Admissible Accumulator Temperature min/max (°C) (1)	Weight kg	Gas connection	Dimensions in mm							
							A max Height	B	C	øD	ød	øE	F on flats	G connection
EHV 0.2-350/00-A20AD-200* 10876301120	0.17	350	120	- 6/+80	2.5	5/8" 18 UNF	268	38	27	58	16	39	24	G ½"
EHV 0.5-350/00-A25BD-200* 10876401125	0.6	350	240	- 20/+80	3	5/8" 18 UNF	260	54	27	91	16	50	32	G ¾"
EHV 1-350/00-A25BC-200* 10845601125	1	350	240	- 20/+80	6	7/8" 14 UNF	330	54	66	116	22.5	50	32	G ¾"
EHV 1-350/00-A25BB-200* 10866901125						7/8" 14 UNF								
EHV 1.6-350/90-A25BC-200 10998301125	1.6	350	240	- 20/+80	8	7/8" 14 UNF	442	54	66	116	22.5	50	32	G ¾"
EHV 1.6-350/90-A25BB-200 11123501125						7/8" 14 UNF								
EHV 2.5-350/90-A25DC-200 10854701125	2	350	450	- 20/+80	11	7/8" 14 UNF	549	66	66	116	22.5	68	50	G 1 ¼"
EHV 2.5-350/90-A25DB-200 10866601125						7/8" 14 UNF								
EHV 4-350/90-A25DC-200 10845401125	3.7	350	450	- 20/+80	15	7/8" 14 UNF	434	65	66	170	22.5	68	50	G 1 ¼"
EHV 4-350/90-A25DB-200 10866101125						7/8" 14 UNF								
EHV 5-350/90-A25DC-200 10861201125	5	350	450	- 20/+80	17	7/8" 14 UNF	898	66	66	116	22.5	68	50	G 1 ¼"
EHV 5-350/90-A25DB-200 10866701125						7/8" 14 UNF								
EHV 6-350/90-A25DC-200 10857401125	6.0	350	450	- 20/+80	20	7/8" 14 UNF	560	65	66	170	22.5	68	50	G 1 ¼"
EHV 6-350/90-A25DB-200 10866201125						7/8" 14 UNF								
EHV 10-350/90-A25DC-200 10859701125	10	350	450	- 20/+80	31	7/8" 14 UNF	825	65	66	170	22.5	68	50	G 1 ¼"
EHV 10-350/90-A25DB-200 10866301125						7/8" 14 UNF								

(1) Temperature range can change depending on shell and elastomer material. Please see bladder materials and Type (page 87)

Above dimensions are in mm and are subject to manufacturing tolerances.

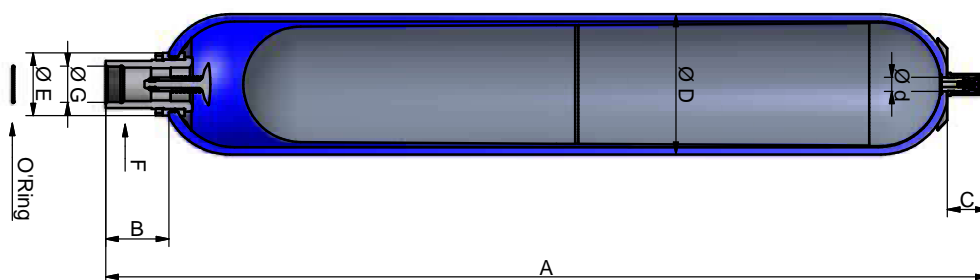

EHV Series 350 bar, 0,5 to 10 Litres, Marine

Standard version (Carbon Steel shell/NBR mix) compatible with mineral oils (2).
 According to PED 2014/68/EU, EN 14359, Fluid Group 2 (3).

Product , Part numbers, Accessories

/43 /24	/13 /11	/23 /41	Valve model see drawing	Adaptor*	Clamps	Support Bracket	Mounting Frame	Lifting Eye on gas side	Complete Repair Kit
/24 : PED&DNV GL /43 : PED Article 4.3& DNV GL	/11 : PED&BV MARINE /13 : PED Article 4.3& BV MARINE	/41 : PED&ABS /23 : PED Article 4.3&ABS		Threaded Part number	Model (quantity) Part number	Model Part number	Model Part number	Model Part number	Model Part number
EHV 0,5-350/43-A25BD-200 11151101125		EHV 0,5-350/23-A25BD-200 11151001125	D	G 3/8" cyl 04556400223	E95 (1) 20250803648				KIT EHV 0.5-350/XX-A25BD 19001100225
EHV 1-350/43-A25BB-200 11168101125	EHV 1-350/13-A25BB-200 11149501125	EHV 1-350/23-A25BB-200 11165801125	B	G 3/8" cyl 04556400223	E114 (1) 20251003648	CE 89 20151903620			KIT EHV 1-350/XX-A25BB 19036400225
EHV 1,6-350/24-A25BB-200 11168201125	EHV 1,6-350/11-A25BB-200 11163301125	EHV 1,6-350/41-A25BB-200 11165901125	B	G 3/8" cyl 04556400223	E114 (1) 20251003648	CE 89 20151903620			KIT EHV 1.6-350/XX-A25BB 19061000225
EHV 2,5-350/24-A25DB-200 11168301125	EHV 2,5-350/11-A25DB-200 11163401125	EHV 2,5-350/41-A25DB-200 11166001125	B	G 3/4" cyl 04555200223	E114 (2) 20251003648	CE 89 20151903620		19036500225	KIT EHV 2.5-350/XX-A25DB 19036500225
EHV 4-350/24-A25DB-200 11168501125	EHV 4-350/11-A25DB-200 10998101125	EHV 4-350/41-A25DB-200 11166201125	B	G 3/4" cyl 04555200223	E168 (1) 20251303648	CE108 20118703620	EF1 20217500125	10912700200	KIT EHV 4-350/XX-A25DB 19036600225
EHV 5-350/24-A25DB-200 11168401125	EHV 5-350/11-A25DB-200 11163501125	EHV 5-350/41-A25DB-200 11166101125	B	G 3/4" cyl 04555200223	E114 (2) 20251003648	CE 89 20151903620		10912700200	KIT EHV 5-350/XX-A25DB 19036700225
EHV 6-350/24-A25DB-200 11168601125	EHV 6-350/11-A25DB-200 11163601125	EHV 6-350/41-A25DB-200 11166301125	B	G 3/4" cyl 04555200223	E168 (2) 20251303648	CE108 20118703620	EF1 20217500125	10912700200	KIT EHV 6-350/XX-A25DB 19036800225
EHV 10-350/24-A25DB-200 11168701125	EHV 10-350/11-A25DB-200 11163701125	EHV 10-350/41-A25DB-200 11166401125	B	G 3/4" cyl 04555200223	E168 (2) 20251303648	CE108 20118703620	EF1 20217500125	10912700200	KIT EHV 10-350/XX-A25DB 19036900225

(2) For other fluids consult Parker

(3) For Fluid group 1 consideration : consult Parker

* For more adaptor options see pages 74&75.

Model of valve stem
 7/8" 14 UNF
 (B)



Model of valve stem
 integrated
 5/8" 18 UNF
 (D)



Volume in Litres	Max. Working Pressure (bar)	Effective Gas vol. Litres	Max. Working pressure (PS) bar	Max Flow Rate l/min	Admissible Accumulator Temperature min/max (°C) (1)	Weight (kg)	Gas connection	Dimensions in mm							
								A max Height	B	C	øD	ød	øE	F on flats	G connection
EHV 0.5L	330	0.6	350	240	- 20/+80	3	5/8" 18 UNF	260	54	27	91	16	50	32	G ¾"
EHV 1L	350	1	350	240	- 20/+80	6	7/8" 14 UNF	330	54	66	116	22.5	50	32	G ¾"
EHV 1.6L	350	1.6	350	240	- 20/+80	8	7/8" 14 UNF	442	54	66	116	22.5	50	32	G ¾"
EHV 2.5L	350	2.4	350	450	- 20/+80	11	7/8" 14 UNF	549	66	66	116	22.5	68	50	G 1 ¼"
EHV 4L	350	3.7	350	450	- 20/+80	15	7/8" 14 UNF	434	65	66	170	22.5	68	50	G 1 ¼"
EHV 5L	350	5	350	450	- 20/+80	17	7/8" 14 UNF	898	66	66	116	22.5	68	50	G 1 ¼"
EHV 6L	350	6	350	450	- 20/+80	20	7/8" 14 UNF	560	65	66	170	22.5	68	50	G 1 ¼"
EHV 10L	350	10	350	450	- 20/+80	31	7/8" 14 UNF	825	65	66	170	22.5	68	50	G 1 ¼"

(1)Temperature range can change depending on shell and elastomer material. Please see bladder materials and Type (page 87)
 Above dimensions are in mm and are subject to manufacturing tolerances.

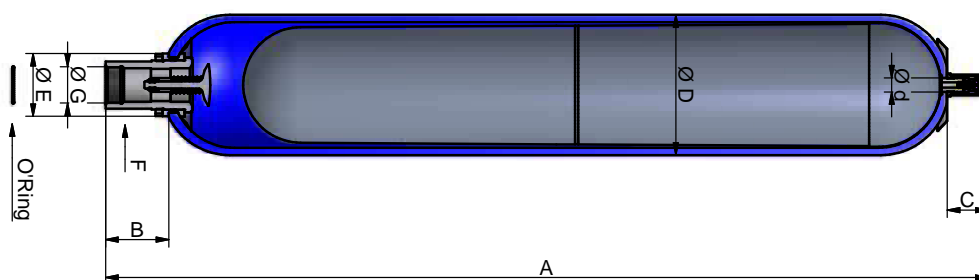

EHV Series 480 bar, 10 to 50 Litres

Standard version (Carbon Steel shell/NBR mix) compatible with mineral oils (2).
 According to PED 2014/68/EU, EN 14359, Fluid Group 2 (3).

Product Prices, Part numbers, Accessories

Type Part number	Adaptor*	Clamps	Support Bracket	Mounting Frame	Complete Repair Kit
	Threaded Part number	Model (quantity) Part number	Model Part number	Model Part number	Model Part number
EHV 10-480/90-A25GE-200 11218201125	G 1" cyl 04557000223	D226 (2) 20251503648	CE159A 20109003620	EF2 20217600125	KIT EHV 10-480/90-A25GE 19055702525
EHV 12-480/90-A25GE-200 11218301125	G 1" cyl 04557000223	D226 (2) 20251503648	CE159A 20109003620	EF2 20217600125	KIT EHV 12-480/90 19063002525
EHV 20-480/90-A25GE-200 11218401125	G 1" cyl 04557000223	D226 (2) 20251503648	CE159A 20109003620	EF2 20217600125	KIT EHV 20-480/90-A25GE 19050002525
EHV 32-480/90-A25GE-200 11218501125	G 1" cyl 04557000223	D226 (2) 20251503648	CE159A 20109003620	EF3 20217700125	KIT EHV 32-480/90-A25GE 19051302525
EHV 50-480/90-A25GE-200 11218601125	G 1" cyl 04557000223	D226 (2) 20251503648	CE159A 20109003620	EF3 20217700125	KIT EHV 50-480/90-A25GE 19068102525

(2) For other fluids consult Parker

(3) For Fluid group 1 consideration : consult Parker

For pre-charge over 300 bar please consult Division

* For more adaptor options see pages 74&75.

Model of valve stem
 7/8" 14 UNF
 (E)

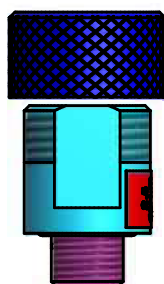

Type	Effective Gas vol. Litres	Max. Working pressure (PS) bar	Max Flow Rate l/min	Admissible Accumulator Temperature min/max (°C) (1)	Weight kg	Gas connection	Dimensions in mm							
							A max Height	B	C	øD	ød	øE	F on flats	G connection
EHV 10-480/90-A25GE-200	9.2	480	900	- 20/+80	33	7/8" 14 UNF	593	103	74	228	22.5	101	70	G 2"
EHV 12-480/90-A25GE-200	11	480	900	- 20/+80	43	7/8" 14 UNF	693	103	74	228	22.5	101	70	G 2"
EHV 20-480/90-A25GE-200	17.8	480	900	- 20/+80	63	7/8" 14 UNF	903	103	74	228	22.5	101	70	G 2"
EHV 32-480/90-A25GE-200	32	480	900	- 20/+80	97	7/8" 14 UNF	1428	103	74	228	22.5	101	70	G 2"
EHV 50-480/90-A25GE-200	48.5	480	900	- 20/+80	132	7/8" 14 UNF	1943	103	74	228	22.5	101	70	G 2"

(1)Temperature range can change depending on shell and elastomer material. Please see bladder materials and Type (page 87)
 Above dimensions are in mm and are subject to manufacturing tolerances.

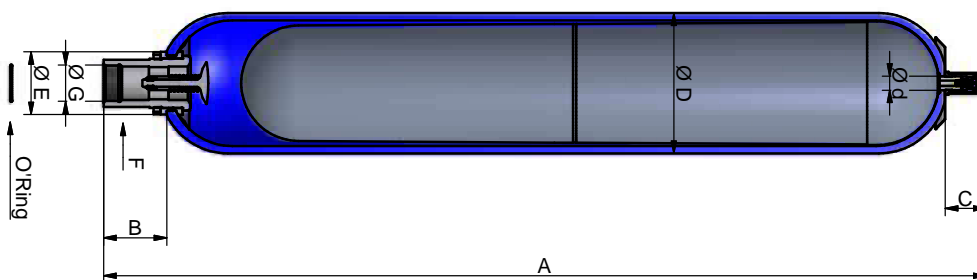

EHV Series 690 bar, 1 to 54 Litres

Standard version (Carbon Steel shell/NBR mix) compatible with mineral oils (2).
 According to PED 2014/68/EU, Fluid Group 2 (3).

Products, Part numbers, Accessories

Type Part number	Adaptor**	Clamps	Support Bracket	Lifting Eye on gas side	Complete Repair Kit
	Threaded Part number	Model (quantity) Part number	Model Part number	Model Part number	Model Part number
EHV 1-690/00-A25CE-200* 10910101125	04579500223	20251003648	20151903620	10912700200	KIT EHV 1-690/00-A25CE 19043500225
EHV 2.5-690/90-A25CE-200 10910201125	04579500223	20251003648	20151903620	10912700200	KIT EHV 2,5-690/00-A25CE 19043600225
EHV 5-690/90-A25CE-200 10910301125	04579500223	20251003648	20151903620	10912700200	KIT EHV 5-690/00-A25CE 19043700225

Type Part number	Adaptor**	Clamps	Support Bracket	Lifting Eye on gas side	Complete Repair Kit
	Threaded Part number	Model (quantity) Part number	Model Part number	Model Part number	Model Part number
EHV 12-690/90-A25GE-200 1203V-DC-691	Consult Parker	11060-DEE	Consult Parker	Consult Parker	KIT EHV 12-690/90-A25GE 19048200225
EHV 20-690/90-A25GE-200 2003V-DC-691		11060-DEE			KIT EHV 20-690/90-A25GE 19048300225
EHV 37-690/90-A25GE-200 3703V-DC-691		11060-DEE			KIT EHV 32-690/90-A25GE 19048400225
EHV 54-690/90-A25GE-200 5403V-DC-691		11060-DEE			KIT EHV 50-690/90-A25GE 19048500225

For pre-charge over 300 bar please consult Division

(2) For other fluids consult Parker

(3) For Fluid group 1 consideration : consult Parker

* According to Article 4.3 PED 2014/68/EU

**For more adaptor options see pages 74&75.

Model of valve stem
 7/8" 14 UNF
 (E)

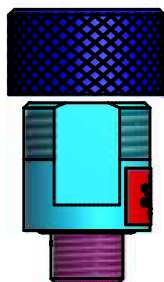

Type	Effective Gas vol. Litres	Max. Working pressure (PS) bar	Max Flow Rate l/min	Admissible Accumulator Temperature min/max (°C) (1)	Weight kg	Gas connection	Dimensions in mm							
							A max Height	B	C	øD	ød	øE	F on flats	G connection
EHV 1-690/00-A25CE-200*	1.1	690	360	- 20/+80	9	7/8" 14 UNF	376	68	69	122	22.5	68	45	G 1"
EHV 2.5-690/90-A25CE-200	2.4	690	360	- 20/+80	15	7/8" 14 UNF	551	68	69	122	22.5	68	45	G 1"
EHV 5-690/90-A25CE-200	5	690	360	- 20/+80	29	7/8" 14 UNF	900	68	69	122	22.5	68	45	G 1"

Type	Effective Gas vol. Litres	Max. Working pressure (PS) bar	Max Flow Rate l/min	Admissible Accumulator Temperature min/max (°C) (1)	Weight kg	Gas connection	Dimensions in mm							
							A max Height	B	C	øD	ød	øE	F on flats	G connection**
EHV 12-690/90-A25GE-200	11	690	900	- 20/+80	97	7/8" 14 UNF	682	84	166	267	50	110	77	G 2"
EHV 20-690/90-A25GE-200	16.5	690	900	- 20/+80	134	7/8" 14 UNF	892	84	166	267	50	110	77	G 2"
EHV 37-690/90-A25GE-200	33.4	690	900	- 20/+80	227	7/8" 14 UNF	1417	84	166	267	50	110	77	G 2"
EHV 54-690/90-A25GE-200	48	690	900	- 20/+80	318	7/8" 14 UNF	1932	84	166	267	50	110	77	G 2"

(1)Temperature range can change depending on shell and elastomer material. Please see bladder materials and Type (page 87)

Above dimensions are in mm and are subject to manufacturing tolerances.

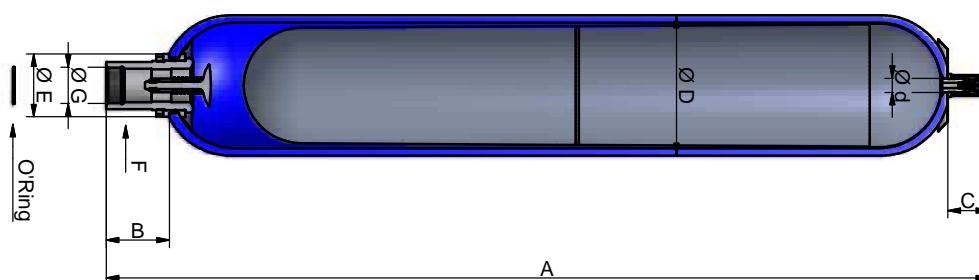

EHVF Series 330 bar, 10 to 57 Litres

Flanged Fluid Port

Standard version (Carbon Steel shell/NBR mix) compatible with mineral oils (2).
 According to PED 2014/68/EU, EN 14359, Fluid Group 2 (3).

Product , Part numbers, Accessories

Type Part number	Kit Flange*	Clamps	Support Bracket	Mounting Frame	Lifting Eye on gas side	Complete Repair Kit
	Type Part number	Model (quantity) Part number	Model Part number	Model Part number	Model Part number	Model Part number
EHVF 10-330/90-A25RA-200 10844901125	BR 400-38 35132400123	D226 (2) 20251503648	CE 159A 20109003620	EF2 20217600125	10912700200	KIT EHVF 10-330/90-A25RA 19034600225
EHVF 12-330/90-A25RA-200 10867301125	BR 400-38 35132400123	D226 (2) 20251503648	CE 159A 20109003620	EF2 20217600125	10912700200	KIT EHVF 12-330/90-A25RA 19034700225
EHVF 20-330/90-A25RA-200 10845001125	BR 400-38 35132400123	D226 (2) 20251503648	CE 159A 20109003620	EF2 20217600125	10912700200	KIT EHVF 20-330/90-A25RA 19034800225
EHVF 24.5-330/90-A25RA-200 10845101125	BR 400-38 35132400123	D226 (2) 20251503648	CE 159A 20109003620	EF2 20217600125	10912700200	KIT EHVF 24.5-330/90-A25RA 19035100225
EHVF 32-330/90-A25RA-200 10845201125	BR 400-38 35132400123	D226 (2) 20251503648	CE 159A 20109003620	EF3 20217700125	10912700200	KIT EHVF 32-330/90-A25RA 19034900225
EHVF 42-330/90-A25RA-200 11132501125	BR 400-38 35132400123	D226 (2) 20251503648	CE 159A 20109003620	EF3 20217700125	10912700200	KIT EHVF 50-330/90-A25RA 19062200225
EHVF 50-330/90-A25RA-200 11077001125	BR 400-38 35132400123	D226 (2) 20251503648	CE 159A 20109003620	EF3 20217700125	10912700200	KIT EHVF 50-330/90-A25RA 19054400225
EHVF 57-330/90-A25RA-200 11132601125	BR 400-38 35132400123	D226 (2) 20251503648	CE 159A 20109003620	EF3 20217700125	10912700200	KIT EHVF 57-330/90-A25RA 19062300225

* see page 76

(2) For other fluids consult Parker

(3) For Fluid group 1 consideration : consult Parker

Model of valve stem
 5/8" 18 UNF
 (A)



Type	Effective Gas vol. Litres	Max. Working pressure (PS) bar	Max Flow Rate l/min	Admissible Accumulator Temperature min/max (°C) (1)	Weight kg	Gas connection	Dimensions in mm									
							A max Height	B	C	øD	ød	øE	F on flats	G connection**	ØL	M
EHVF 10-330/90-A25RA-200	9.2	330	900	- 20/80	31	5/8"18 UNF	627	143	66	226	22.5	101	70	34	63.8	12.5
EHVF 12-330/90-A25RA-200	11	330	900	- 20/80	36	5/8"18 UNF	727	143	66	226	22.5	101	70	34	63.8	12.5
EHVF 20-330/90-A25RA-200	17.8	330	900	- 20/80	49	5/8"18 UNF	937	143	66	226	22.5	101	70	34	63.8	12.5
EHVF 24,5-330/90-A25RA-200	22.5	330	900	- 20/80	56	5/8"18 UNF	1072	143	66	226	22.5	101	70	34	63.8	12.5
EHVF 32-330/90-A25RA-200	32	330	900	- 20/80	81	5/8"18 UNF	1460	143	66	226	22.5	101	70	34	63.8	12.5
EHVF 42-330/90-A25RA-200	42	330	900	- 20/80	87	5/8"18 UNF	1602	143	66	226	22.5	101	70	34	63.8	12.5
EHVF 50-330/90-A25RA-200	48.5	330	900	- 20/80	110	5/8"18 UNF	1976	143	66	226	22.5	101	70	34	63.8	12.5
EHVF 57-330/90-A25RA-200	51	330	900	- 20/80	116	5/8"18 UNF	2072	143	66	226	22.5	101	70	34	63.8	12.5

Note: Connection (norme ISO 6162) Flange 1 1/2" SAE 6000 PSI

(1)Temperature range can change depending on shell and elastomer material. Please see bladder materials and Type (page 87)

Above dimensions are in mm and are subject to manufacturing tolerances.

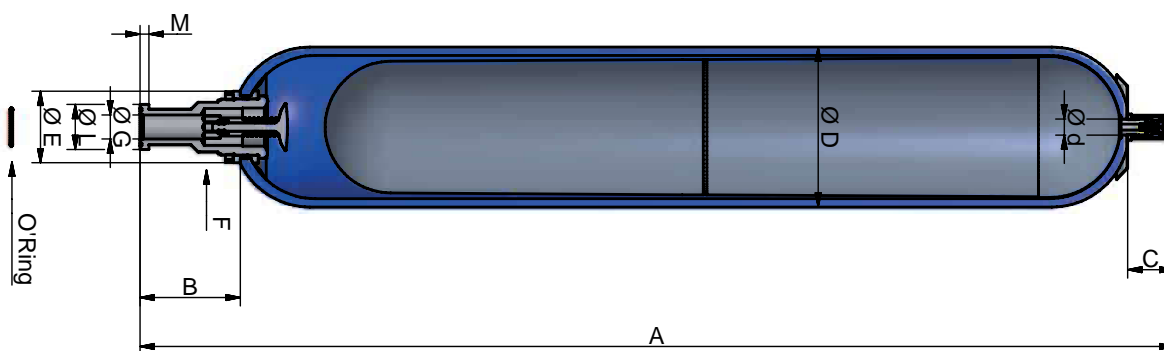

EHVF Series 350 bar, 2.5 to 10 Litres

Flanged Fluid Port

Standard version (Carbon Steel shell/NBR mix) compatible with mineral oils (2).
 According to PED 2014/68/EU, EN 14359, Fluid Group 2 (3).

Product , Part numbers, Accessories, Dimensions

Type Part number	Flange*	Clamps	Support Bracket	Mounting Frame	Lifting Eye on gas side	Complete Repair Kit
	Type Part number	Model (quantity) Part number	Model Part number	Model Part number	Model Part number	Model Part number
EHVF 2.5-350/90-A25SC 10861501125	BR 400-25 35132600123	E114 (2) 20251003648	CE89 20151903620	-	10912700200	KIT EHVF 2.5-350/90-A25SC 19035300225
EHVF 4-350/90-A25SC 10857601125	BR 400-25 35132600123	E168 (1) 20251303648	CE108 20118703620	EF1 20217500125	10912700200	KIT EHVF 4-350/90-A25SC 19035400225
EHVF 5-350/90-A25SC 10861601125	BR 400-25 35132600123	E114 (2) 20251003648	CE89 20151903620	-	10912700200	KIT EHVF 5-350/90-A25SC 19035500225
EHVF 6-350/90-A25SC 10857701125	BR 400-25 35132600123	E168 (1) 20251303648	CE108 20118703620	EF1 20217500125	10912700200	KIT EHVF 6-350/90-A25SC 19035600225
EHVF 10-350/90-A25SC 10859901125	BR 400-25 35132600123	E168 (2) 20251303648	CE108 20118703620	EF1 20217500125	10912700200	KIT EHVF 10-350/90-A25SC 19035700225

*see flanges page 76

(2) For other fluids consult Parker

(3) For Fluid group 1 consideration : consult Parker

Model of valve stem
 integrated
 7/8"14 UNF
 (C)



Type	Effective Gas vol. Litres	Max. Working pressure (PS) bar	Max Flow Rate l/min	Admissible Accumulator Temperature min/max (°C) (1)	Weight kg	Gas connection	Dimensions in mm									
							A max Height	B	C	øD	ød	øE	F on flats	G connection **	ØL	M
EHVF 2.5-350/90-A25SC	2.4	350	450	- 20/80	11	7/8" 14 UNF	595	111	66	116	22.5	68	50	22	47.9	9.5
EHVF 4-350/90-A25SC	3.7	350	450	- 20/80	15	7/8" 14 UNF	480	110	66	170	22.5	68	50	22	47.9	9.5
EHVF 5-350/90-A25SC	5.0	350	450	- 20/80	17	7/8" 14 UNF	944	111	66	116	22.5	68	50	22	47.9	9.5
EHVF 6-350/90-A25SC	6.0	350	450	- 20/80	20	7/8" 14 UNF	606	110	66	170	22.5	68	50	22	47.9	9.5
EHVF 10-350/90-A25SC	10	350	450	- 20/80	31	7/8" 14 UNF	871	110	66	170	22.5	68	50	22	47.9	9.5

Note: Connection (norme ISO 6162): 1" SAE 6000 PSI. Flange PN400 DN25

(1)Temperature range can change depending on shell and elastomer material. Please see bladder materials and Type (page 87)

Above dimensions are in mm and are subject to manufacturing tolerances.

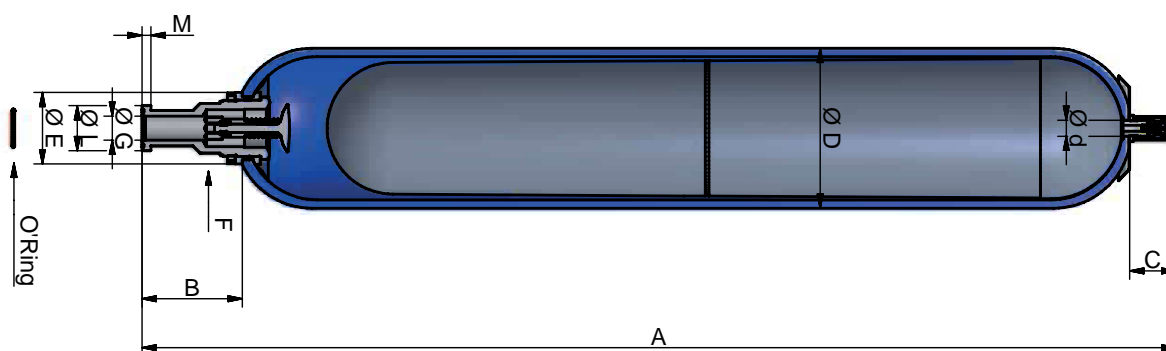

EHV Series 330 bar, 10 to 57 Litres

High Flow fluid port, 1200 l/min

Standard version (Carbon Steel shell/NBR mix) compatible with mineral oils (2).

According to PED 2014/68/EU, EN 14359, Fluid Group 2 (3).

Product , Part numbers, Accessories, Dimensions

Type Part number	Adaptor*	Clamps	Support Bracket	Mounting Frame	Lifting Eye on gas side	Complete Repair Kit
	Threaded Part number	Model (quantity) Part number	Model Part number	Model Part number	Model Part number	Model Part number
EHV 10-330/90-A25HA-200 10874801125	G 1" cyl 04557000223	D226 (2) 20251503648	CE 159A 20109003620	EF2 20217600125	10912700200	KIT EHV 10-330/90-A25HA-200 19028900225
EHV 12-330/90-A25HA-200 10874901125	G 1" cyl 04557000223	D226 (2) 20251503648	CE 159A 20109003620	EF2 20217600125	10912700200	KIT EHV 12- 330/90-A25HA-200 19032100225
EHV 20-330/90-A25HA-200 10846301125	G 1" cyl 04557000223	D226 (2) 20251503648	CE 159A 20109003620	EF2 20217600125	10912700200	KIT EHV 20- 330/90-A25HA-200 19029000225
EHV 24.5-330/90-A25HA-200 10875001125	G 1" cyl 04557000223	D226 (2) 20251503648	CE 159A 20109003620	EF2 20217600125	10912700200	KIT EHV 24.5-330/90-A25HA-200 19029400225
EHV 32-330/90-A25HA-200 10846501125	G 1" cyl 04557000223	D226 (2) 20251503648	CE 159A 20109003620	EF3 20217700125	10912700200	KIT EHV 32-330/90-A25HA-200 19029100225
EHV 42-330/90-A25HA-200 11145201125	G 1" cyl 04557000223	D226 (2) 20251503648	CE 159A 20109003620	EF3 20217700125	10912700200	KIT EHV 42-330/90-A25HA-200 19060800225
EHV 50-330/90-A25HA-200 11091501125	G 1" cyl 04557000223	D226 (2) 20251503648	CE 159A 20109003620	EF3 20217700125	10912700200	KIT EHV 50-330/90-A25HA-200 19054100225
EHV 57-330/90-A25HA-200 11145401125	G 1" cyl 04557000223	D226 (2) 20251503648	CE 159A 20109003620	EF3 20217700125	10912700200	KIT EHV 57-330/90-A25HA-200 19060900225

(2) For other fluids consult Parker

(3) For Fluid group 1 consideration : consult Parker

* For more adaptor options see pages 74 & 75.

Model of valve stem
 5/8" 18 UNF
 (A)



Type	Effective Gas vol. Litres	Max. Working pressure (PS) bar	Max Flow Rate l/min	Admissible Accumulator Temperature min/max (°C) (1)	Weight kg	Gas connection	Dimensions in mm							
							A max Height	B	C	øD	ød	øE	F on flats	G connection
EHV 10-330/90-A25HA-200	9.2	330	1200	- 20/80	31	5/8"18 UNF	587	103	66	226	22.5	101	70	G 2"
EHV 12-330/90-A25HA-200	11	330	1200	- 20/80	36	5/8"18 UNF	687	103	66	226	22.5	101	70	G 2"
EHV 20-330/90-A25HA-200	17.8	330	1200	- 20/80	49	5/8"18 UNF	897	103	66	226	22.5	101	70	G 2"
EHV 24.5-330/90-A25HA-200	22.5	330	1200	- 20/80	56	5/8"18 UNF	1032	103	66	226	22.5	101	70	G 2"
EHV 32-330/90-A25HA-200	32	330	1200	- 20/80	81	5/8"18 UNF	1420	103	66	226	22.5	101	70	G 2"
EHV 42-330/90-A25HA-200	42	330	1200	- 20/80	87	5/8"18 UNF	1562	103	66	226	22.5	101	70	G 2"
EHV 50-330/90-A25HA-200	48.5	330	1200	- 20/80	110	5/8"18 UNF	1936	103	66	226	22.5	101	70	G 2"
EHV 57-330/90-A25HA-200	51	330	1200	- 20/80	116	5/8"18 UNF	2032	103	66	226	22.5	101	70	G 2"

(1)Temperature range can change depending on shell and elastomer material. Please see bladder materials and Type (page 87)

Above dimensions are in mm and are subject to manufacturing tolerances.

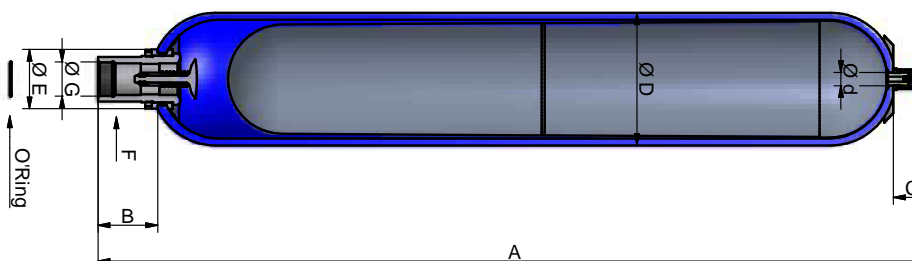

EHV-DA Series 350 bar, 2.5 to 10 Litres

High Flow fluid port, 570 l/min

Standard version (Carbon Steel shell/NBR mix) compatible with mineral oils (2).
 According to PED 2014/68/EU, EN 14359, Fluid Group 2 (3).

Product, Part numbers, Accessories, Dimensions

Type Part number	Adaptor*	Clamps	Support Bracket	Mounting Frame	Lifting Eye	Complete Repair Kit
	Threaded Part number	Model (quantity) Part number	Model Part number	Model Part number	Model Part number	Model Part number
EHV 2.5-350/90-A25EC-200 10846101125	G 3/4" cyl 04555200223	E114 (2) 20251003648	CE 89 20151903620	-	-	KIT EHV 2.5-350/90-A25EC 19029800225
EHV 4-350/90-A25EC-200 10846701125	G 3/4" cyl 04555200223	E168 (2) 20251303648	CE108 20118703620	EF1 20217500125	-	KIT EHV 4-350/90-A25EC 19029900225
EHV 5-350/90-A25EC-200 10874601125	G 3/4" cyl 04555200223	E114 (2) 20251003648	CE 89 20151903620	-	-	KIT EHV 5-350/90-A25EC 19030000225
EHV 6-350/90-A25EC-200 10874701125	G 3/4" cyl 04555200223	E168 (2) 20251303648	CE108 20118703620	EF1 20217500125	-	KIT EHV 6-350/90-A25EC 19030100225
EHV 10-350/90-A25EC-200 10845901125	G 3/4" cyl 04555200223	E168 (2) 20251303648	CE108 20118703620	EF1 20217500125	10912700200	KIT EHV 10- 350/90-A25EC 19030200225

* For more adaptor options see pages 74 & 75.

(2) For other fluids consult Parker

(3) For Fluid group 1 consideration : consult Parker

Model of valve stem integrated
 7/8"14 UNF
 (C)



Type	Effective Gas vol. Litres	Max. Working pressure (PS) bar	Max Flow Rate l/min	Admissible Accumulator Temperature min/max (°C) (1)	Weight kg	Gas connection	Dimensions in mm							
							A max Height	B	C	øD	ød	øE	F on flats	G connection
EHV 2.5-350/90-A25EC-200	2.4	350	570	- 20/+80	11	7/8" 14 UNF	549	66	66	116	22.5	68	50	G 1¼"
EHV 4-350/90-A25EC-200	3.7	350	570	- 20/+80	15	7/8" 14 UNF	434	65	66	170	22.5	68	50	G 1¼"
EHV 5-350/90-A25EC-200	5	350	570	- 20/+80	17	7/8" 14 UNF	898	66	66	116	22.5	68	50	G 1¼"
EHV 6-350/90-A25EC-200	6	350	570	- 20/+80	20	7/8" 14 UNF	560	65	66	170	22.5	68	50	G 1¼"
EHV 10-350/90-A25EC-200	10	350	570	- 20/+80	31	7/8" 14 UNF	825	65	66	170	22.5	68	50	G 1¼"

(1)Temperature range can change depending on shell and elastomer material. Please see bladder materials and Type (page 87)
 Above dimensions are in mm and are subject to manufacturing tolerances.

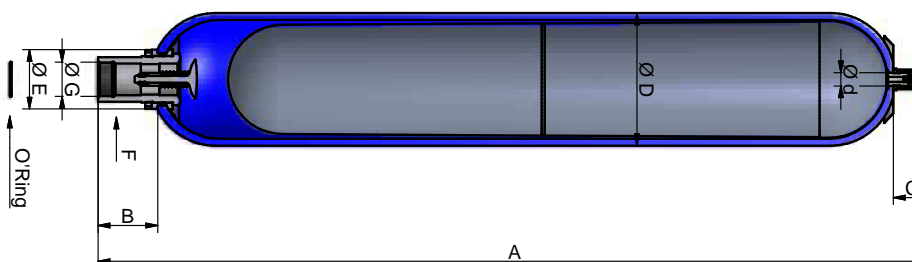

IHV Series 70 bar, 10 to 50 Litres

Standard version (**Stainless Steel** shell/compatible with mineral oils) (2).

According to ASME VIII Division I U STAMPED

Product Prices, Part numbers, Accessories, Dimensions

Type Part number	Part Number	Adaptor	Flange	Clamps	Support Bracket	Complete Repair Kit
		Threaded Part number	Threaded Part number	Model (quantity) Part number	Model Part number	Model Part number
IHV 10-70	J30100706169R80EX	Various adaptors and flanges available Consult Division		D226 (2) 20251503648	CE159A 20109003620	8590018-xyxy 8590019-xyxy
				D226 (2) 20251503648	CE159A 20109003620	8590020-xyxy 8590021-xyxy
D226 (2) 20251503648	CE159A 20109003620			8590022-xyxy 8590023-xyxy		
D226 (2) 20251503648	CE159A 20109003620			8590024-xyxy 8590025-xyxy		
D226 (2) 20251503648	CE159A 20109003620			8590026-xyxy 8590027-xyxy		
D226 (2) 20251503648	CE159A 20109003620			8590028-xyxy 8590029-xyxy		

Available in PED 2014/68/EU (EHV version)

Possibility in carbon steel material, Duplex and Superduplex

(2) For other fluids consult Parker

Type	Effective Gas vol. Litres	Max. Working pressure (PS) bar	Admissible Accumulator Temperature min/max (°C)	Weight kg	Dimensions in mm				
					A max Height	øD	B (G2")	B (3/4" BSP)	C
IHV 10.70	11.5	70	-20/100	27	394	220	103	-	66
							-	68	
IHV 12.70	14.5	70	-20/100	32	493	220	103	-	66
							-	68	
IHV 20.70	21.2	70	-20/100	41	703	220	103	-	66
							-	68	
IHV 24,5.70	25.5	70	-20/100	50	851	220	103	-	66
							-	68	
IHV 32.70	38.0	70	-20/100	65	1225	220	103	-	66
							-	68	
IHV 50.70	54.5	70	-20/100	87	1740	220	103	-	66
							-	68	

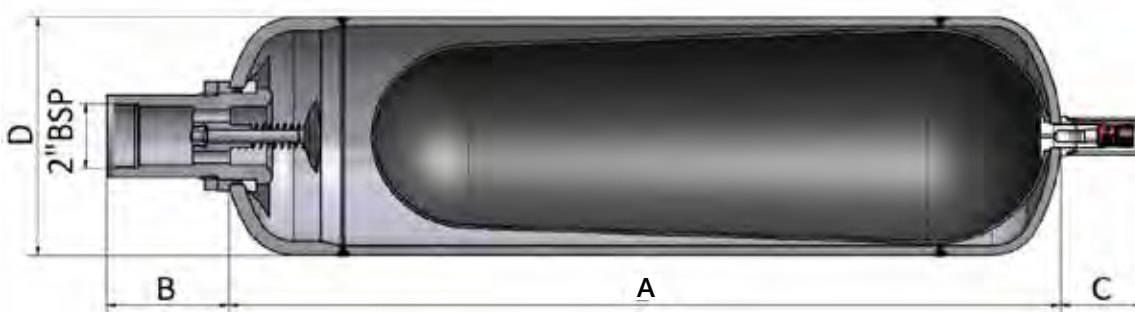
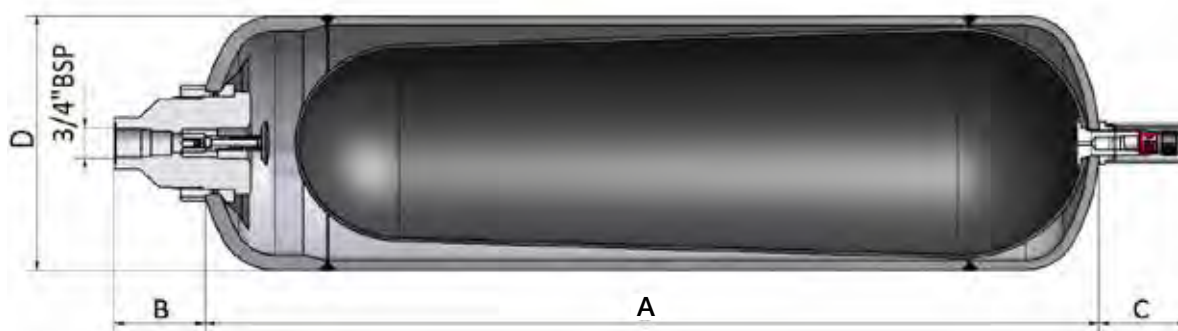

IHV Series 110 bar, 10 to 50 Litres

Standard version (**Stainless Steel** shell/compatible with mineral oils) (2).

According to ASMEVIII Division I U STAMPED

Type	Part Number	Adaptor	Flange	Clamps	Support Bracket	Complete Repair Kit
				Model (quantity) Part number	Model Part number	Model Part number
IHV 10-120	JL301011052CXR25	Various adaptors and flanges available Consult Division		D226 (2)	CE159A	8590018-xyxy
	0104012R15102			20251503648	20109003620	8590019-xyxy
IHV 12-110	JL301211052CXR25			D226 (2)	CE159A	8590020-xyxy
	JL30121105CCXR25			20251503648	20109003620	8590021-xyxy
IHV 20-122	JL302011052CXR25			D226 (2)	CE159A	8590022-xyxy
	01050122U01125FCH			20251503648	20109003620	8590023-xyxy
IHV 24,5-110	JL302411052CXR25			D226 (2)	CE159A	8590024-xyxy
	JL30241105CCXR25	20251503648	20109003620	8590025-xyxy		
IHV 32-129	JL30321105CCXR25	D226 (2)	CE159A	8590026-xyxy		
	K1032129500XT40	20251503648	20109003620	8590027-xyxy		
IHV 50-122	JL305011052CXR25	D226 (2)	CE159A	8590028-xyxy		
	01070122U01025FCH	20251503648	20109003620	8590029-xyxy		

Available in PED 2014/68/EU (EHV version)

Available in carbon steel version, Duplex and Superduplex

(2) For other fluids consult Parker

Type	Effective Gas vol. Litres	Max. Working pressure (PS) bar	Admissible Accumulator Temperature min/max (°C)	Weight kg	Dimensions in mm				
					A max Height	øD	B (G2")	B (3/4" BSP)	C
IHV 10-120	10.3	110	-20/100	48	405	226	103 -	- 68	66
IHV 12-110	13.1	110	-20/100	59	504	226	103 -	- 68	66
IHV 20-122	19.7	110	-20/100	82	714	226	103 -	- 68	66
IHV 24,5-110	23.9	110	-20/100	90	862	226	103 -	- 68	66
IHV 32-129	36.1	110	-20/100	123	1233	226	103 -	- 68	66
IHV 50-122	52.2	110	-20/100	157	1752	226	103 -	- 68	66

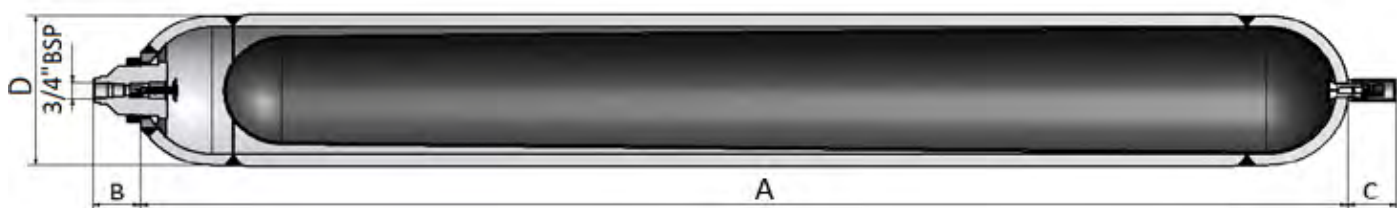
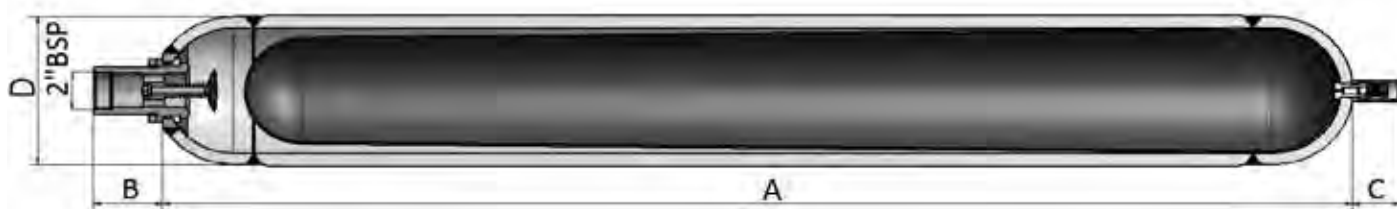

IHV Series 110 bar, 10 to 50 Litres

Standard version (**Stainless Steel** shell/compatible with mineral oils) (2).

According to ASME VIII Division I U STAMPED

Product Prices, Part numbers, Accessories, Dimensions

Type	Part Number	Adaptor	Flange	Clamps	Support Bracket	Complete Repair Kit
				Model (quantity) Part number	Model Part number	Model Part number
IHV 10-110	JS301011052CXR25	Various adaptors and flanges available Consult Division		D226 (2)	CE159A	8590018-xyxy
	JS30101105CCXR25			20251503648	20109003620	8590019-xyxy
IHV 12-110	JS301211052CXR25			D226 (2)	CE159A	8590020-xyxy
	JS30121105CCXR25			20251503648	20109003620	8590021-xyxy
IHV 20-110	JS302011052CXR25			D226 (2)	CE159A	8590022-xyxy
	JS30201105CCXR25			20251503648	20109003620	8590023-xyxy
IHV 24,5-110	JS302411052CXR25			D226 (2)	CE159A	8590024-xyxy
	JS30241105CCXR25			20251503648	20109003620	8590025-xyxy
IHV 32-110	JS303211052CXR25			D226 (2)	CE159A	8590026-xyxy
	JS30321105CCXR25			20251503648	20109003620	8590027-xyxy
IHV 50-110	JS305011052CXR25			D226 (2)	CE159A	8590028-xyxy
	JS30501105CCXR25			20251503648	20109003620	8590029-xyxy

Available in PED 2014/68/EU (EHV version)

Possibility in carbon steel material, Duplex and Superduplex

(2) For other fluids consult Parker

Type	Effective Gas vol. Litres	Max. Working pressure (PS) bar	Admissible Accumulator Temperature min/max (°C)	Weight kg	Dimensions in mm				
					A max Height	øD	B (G2")	B (3/4" BSP)	C
IHV 10-110	10.3	110	-20/100	46	400	226	103	-	66
							-	68	
IHV 12-110	13.1	110	-20/100	58	498	226	103	-	66
							-	68	
IHV 20-110	19.7	110	-20/100	70	708	226	103	-	66
							-	68	
IHV 24,5-110	23.9	110	-20/100	80	856	226	103	-	66
							-	68	
IHV 32-110	36.1	110	-20/100	105	1227	226	103	-	66
							-	68	
IHV 50-110	52.2	110	-20/100	138	1754	226	103	-	66
							-	68	

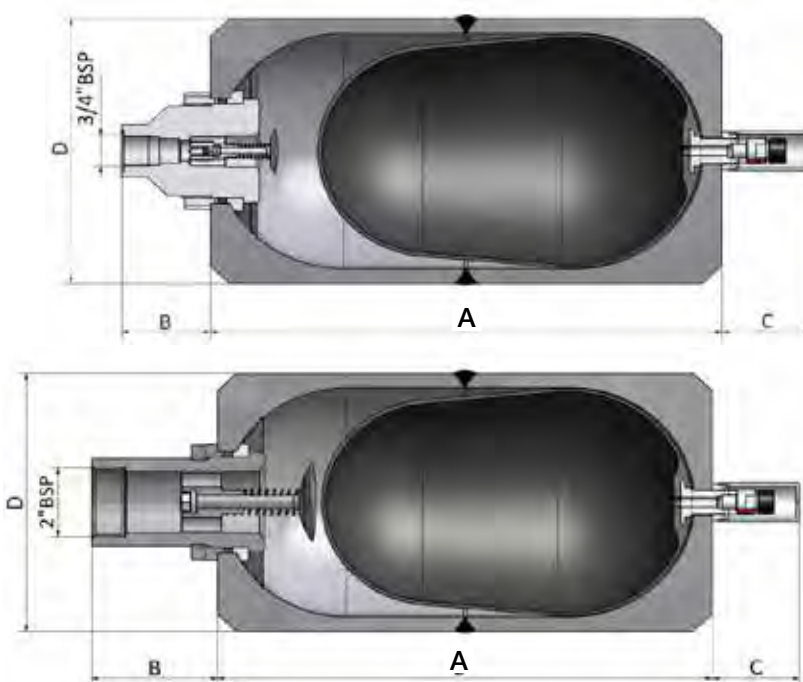

EHV Series 120 bar, 1 to 5 Litres

Standard version (Stainless Steel shell/NBR mix) compatible with mineral oils (2).
 According to PED 2014/68/EU, AD 2000, Fluid Group 2 (3).

Product Prices, Part numbers, Accessories, Dimensions

Type Part number	Pre-charge		Adaptor**	Clamps	Support Bracket	Complete Repair Kit
	1 - 109 bar	110 - 209 bar	Threaded Part number	Part number	Model Part number	Model Part number
EHV 1-120/00-I25DC-200* 10953701925	751001	751030	G 3/4" cyl 04555201723	10981	CE 89 20151901220	KIT 1-120/00-I25DC 19039501725
EHV 2.5-120/90-I25DC-200 10953401925	751002	751031	G 3/4" cyl 04555201723	10981	CE 89 20151901220	KIT 2.5-120/90-I25DC 19029801725
EHV 5-120/90-I25DC-200 10953501925	751003	751032	G 3/4" cyl 04555201723	10981	CE 89 20151901220	KIT EHV 5-120/90-I25DC 19030001725

(2) For other fluids consult Parker

(3) For Fluid group 1 consideration : consult Parker

* According to Article 4.3 PED 2014/68/EU

** For more adaptor options see pages 74&75.

Model of valve stem
 integrated
 7/8"14 UNF
 (C)



Type	Effective Gas vol. Litres	Max. Working pressure (PS) bar	Max Flow Rate l/min	Admissible Accumulator Temperature min/max (°C) (1)	Weight kg	Gas connection	Dimensions in mm							
							A max Height	B	C	øD	ød	øE	F on flats	G connection
EHV 1-120/00-I25DC-200*	1	120	450	- 20/80	6	7/8" 14 UNF	345	67	66	116	22.5	68	50	G 11/4"
EHV 2.5-120/90-I25DC-200 EHV 5-120/90	2.4 5	120 120	450 450	- 20/80	11 17	7/8" 14 UNF	542 891	67	66	116	22.5	68	50	G 11/4"
EHV 5-120/90-I25DC-200	5	120	450	- 20/80	17	7/8" 14 UNF	891	67	66	116	22.5	68	50	G 11/4"

(1)Temperature range can change depending on shell and elastomer material. Please see bladder materials and Type (page 87)

Above dimensions are in mm and are subject to manufacturing tolerances.

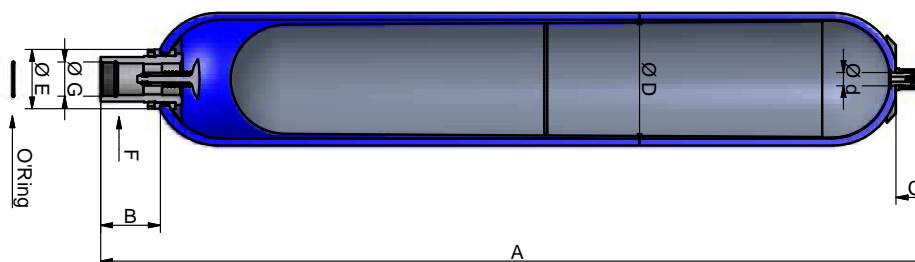

Adaptors EHV Carbon Steel

Accumulator model	Connection ØF gas cylinder	Connection ØI gas cylinder	P/N	Shape	J/Flats	K	O-Ring / Back-up ring
EHV 0,2 Litre 350 bar	G 1/2"	G 1/4"	04556500223	A	27	8	O-ring 18x2
		Blind	04501800223	A	27	8	O-ring 18x2
EHV 0,5 & 1 & 1,6 Litres 350 bar	G 3/4"	G 3/8"	04556400223	A	32	8	O-ring 21,3x2,4
			04556100223	B	32	8	O-ring 16,9x2,7
		Blind	04502000223	A	32	8	O-ring 21,3x2,4
			04558200223	B	32	8	O-ring 16,9x2,7
EHV 1 to 5 Litres 690 bar	G1"	G 1/2"	04579500223	B	41	10	O-ring 21,3x3,6 / BUR 22x28x0,69*2
		Blind	04579600223	B	41	10	O-ring 21,3x3,6 / BUR 22x28x0,69*2
EHV 2,5 to 10 Litres 350 bar	G1"1/4	G 1/2"	04555100233	A	50	10	O-ring 36,2x3
			04555800233	B	50	10	O-ring 30x3
		G 3/4"	04555200223	A	50	10	O-ring 36,2x3
			04555900223	B	50	10	O-ring 30x3
		G 1"	04583100223	A	50	40	O-ring 36,2x3
		Blind	04502200223	A	50	10	O-ring 36,2x3
04558300233	B		50	10	O-ring 30x3		
EHV 10 to 57 Litres 330 bar	G2"	G 1/2"	04556800223	A	65	13	O-ring 54x3
			04557700223	B	65	13	O-ring 48x3
		G 3/4"	04556900223	A	65	13	O-ring 54x3
			04557800223	B	65	13	O-ring 48x3
		G 1"	04557000223	A	65	13	O-ring 54x3
			04557900233	B	65	13	O-ring 48x3
		G 1"1/4	04557100223	A	65	13	O-ring 54x3
			04558000223	B	65	13	O-ring 48x3
Blind	04502400223	A	65	13	O-ring 54x3		
	04558400223	B	65	13	O-ring 48x3		
EHV 10 to 50 Litres 480 bar	G2"	G 1/2"	04556802523	A	65	13	O-ring 54x3
			04557702523	B	65	13	O-ring 48x3
		G 3/4"	04556902523	A	65	13	O-ring 54x3
			04557802523	B	65	13	O-ring 48x3
		G 1"	04557002523	A	65	13	O-ring 54x3
			04557902523	B	65	13	O-ring 48x3
		G 1"1/4	04557102523	A	65	13	O-ring 54x3
			04558002523	B	65	13	O-ring 48x3
Blind	04502402523	A	65	13	O-ring 54x3		
	04558402523	B	65	13	O-ring 48x3		
EHV 12 to 54 Litres 690 bar	G2"	G 1"	04579002523	B	65	15	O-ring 43,82x5,33 / BUR 45x54x0,85*2
		Blind	04579202523	B	65	15	O-ring 43,82x5,33 / BUR 45x54x0,85*2

Shape A - Seal in angle

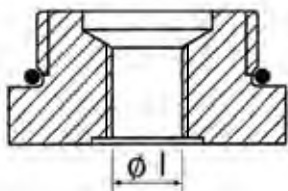

Threaded

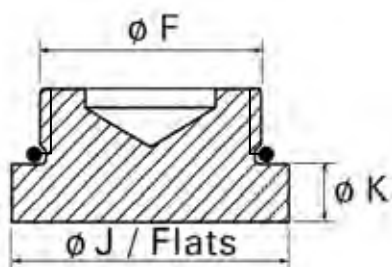

Blind

Shape B - Seal in fluid port

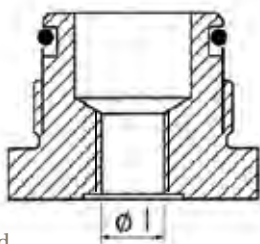

Threaded

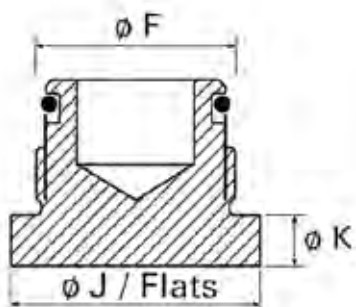

Blind

Flanges EHVF Carbon Steel

Accumulator model	Type	Part Number	A	B	C	D	F	øG	ØH	L	M
EHVF 2,5 to 10 Litres	FLANGE KIT BR 400-25	35132600123	81	70	24	27.8	57.2	32.92	3.53	45	M12
EHVF 10 to 57 Litres	FLANGE KIT BR 400-38	35132400123	113	95	30	36.5	79.3	47.22	3.53	55	M16

According ISO 6162-2

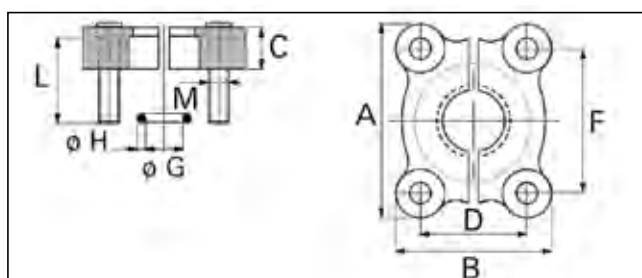

Due to our vast experience in demanding markets such as aerospace, military, nuclear, renewable energies and formula one racing, we are offering an unmatched range of rubber compounds to meet the most difficult applications.

Parker Olaer products are supported all over the globe, and we will meet customer requirements wherever needed. We therefore offer the complete range of approvals, such as all key Marine approvals (BV, DNV, ABS, LR, ...), over and above all country specific approvals (PED, ASME, SELO, CRN, ARH, CUTR, ...).